

BriPower BSL Series

High Power DC Source & Load

Features

- Output Power: 100kW/150kW/200kW/250kW/300kW
- Output Voltage: 1000V/1500V/2000V
- Output Current: *2 / *3 / *4
- Auto-Ranging Output
- Soft start: effectively restrain the impulse current when power on
- Seamless transition between source and sink modes
- Current rise time (0% -90%) <5ms
- CC/CV/CP/CR mode available
- Regenerative DC load function
- Master-Slave interface
- LAN/RS485 interfaces
- Emergency stop button and indicators on front panel
- TFT-Touch panel operation
- Mod-bus protocol
- Output contactor
- Remote sense
- CE conformity
- 13 months Warranty

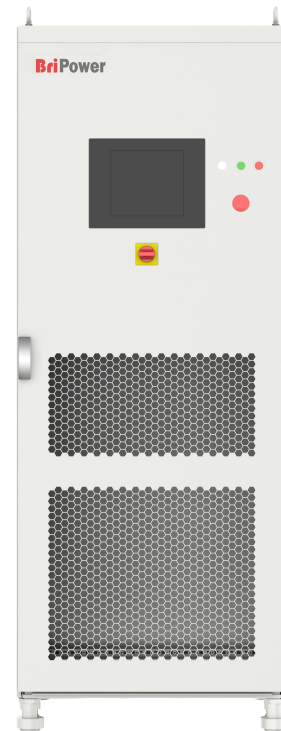

Overview

The BriPower BSL series is IGBT PWM switching DC Power Source & E-Load, which contains multi output power levels 100kW/150kW/200kW/250kW/300kW for single system, up to 4 individual systems can be paralleled to up to 1.2MW system. BSL series has an auto-ranging output function. BSL standard models provide 1000V/1500V/2000V voltage and x2/x3/x4 current.

BSL series uses bi-directional design, which can be used as DC power source or regenerative DC load. CV/CC/CP/CR operation modes are available for both sourcing and sinking.

BSL series adopts dual DSP+FPGA design, with powerful calculation and control capabilities, and can display and save measured values at 10k/s sampling. The BSL series adopts optical fiber communication and performs multiple monitoring and protection of all main components, communication connections and systems. It is a reliable power supply product.

With touch panel on the front panel, users can control the power source through GUI software. System status indicators and emergency stop button are installed on the front panel. RS485 and LAN interfaces are available for automated test applications.

Bi-Directional (Re-generative)

BSL series can operate in source and sink mode. It has the capability to return the energy fully back to the grid.

Re-generative DC Load

BSL series can be used as regenerative DC electronic load. DC load simulation includes constant current, constant resistance, constant voltage, and constant power modes.

Automatic wide range output

BSL series has an automatic wide-range output function, such as: high-voltage small current or low-voltage large current (also applicable in sink power mode). The same model of power supply can cover a wider range of power applications.

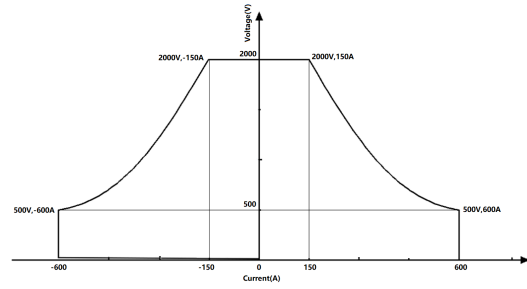

Example: 100kW, 1000V, $\pm 400A$

Battery Test

BSL series provides battery test software and can be used for characterization of power battery packs. It is used to test the charging and discharging performance, temperature rise characteristics, and cycle life of the power battery pack. Through the GUI software, different charging and discharging profiles can be programmed, and test results are displayed in real time.

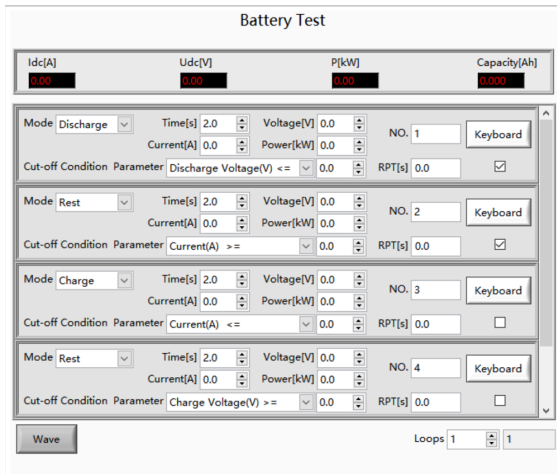

Battery Test

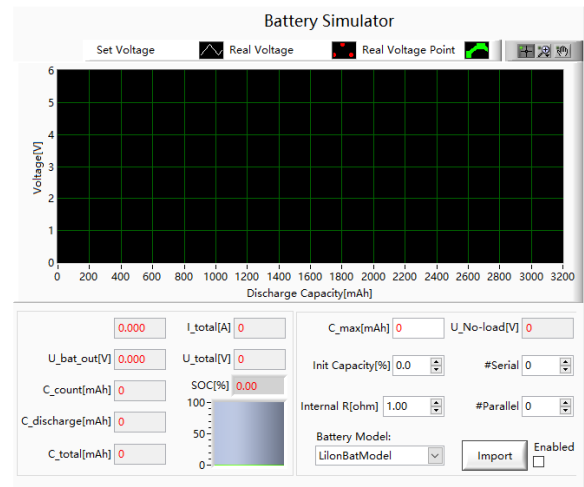

Battery Simulation

Battery Simulation

BSL Series provides battery simulation software and can simulate the charging and discharging characteristics of the power battery pack/package and provide a convenient and efficient testing method for the development and testing of new energy vehicle motors etc.

PV Simulation

BSL series provides PV simulation software and can be used to simulate IV curves of various solar panels, under various temperature and irradiance condition, and conduct static and dynamic MPPT tests according to EN 50530:2010. MPP Update Rate: 200Hz. Irradiance levels: 0 ~ 1500 W/m². Temperature: -10 ~ +100°C. Temperature coefficient: +1% ~ -1%/°C.

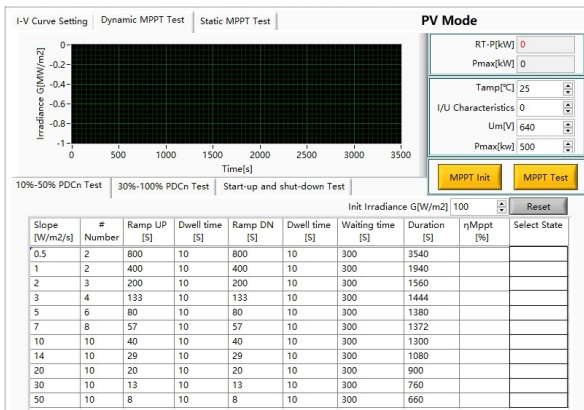

Dynamic MPPT Test

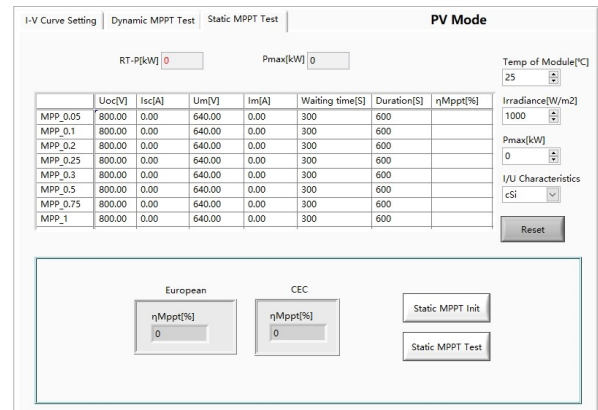

Static MPPT Test

Block Diagram

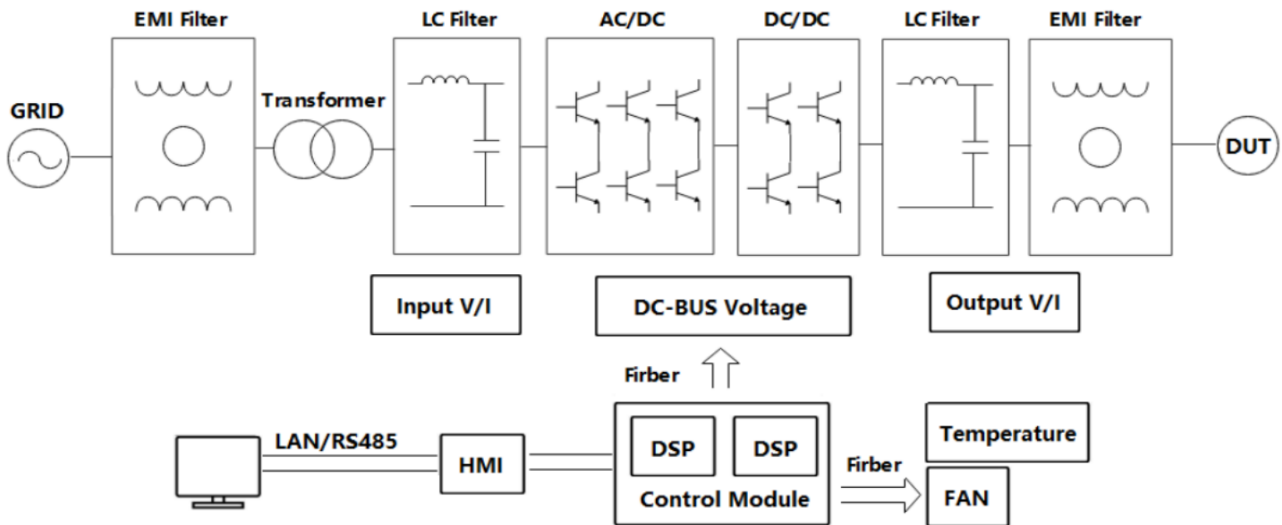

Graphical User Interface

GUI software is installed in front touch panel, which uses Windows OS. The software provides following functions:

- Output settings and limits
- Sequence output settings
- Display measurements: voltage, current, power, etc.
- Capture, display and save output voltage and current waveforms
- Display power source faults

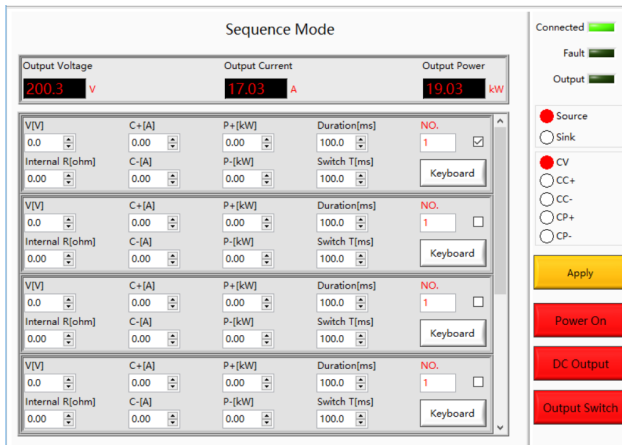

Sequence Programming

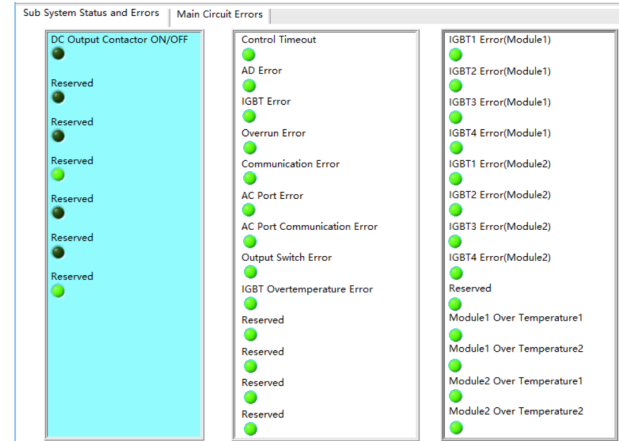

System Status

General Specification

AC Input	
AC input Voltage	3P+N+PE, 380VLL±10%(std)
Frequency	47-63Hz
Efficiency	≥90%
Power Factor	0.95
THDi	≤3%

Output	
Output Modes	CV, CC, CP and CR
Load Regulation	0.1%FS
Line Regulation	0.1%FS
Voltage Ripple	0.2%FS
Stability	0.2%FS
Current Rise Time (0%~90%)	<5ms
Current Rise Time (-90%~90%)	<10ms
Voltage Regulation Time (0-100% Load change)	<5ms
Power Accuracy	0.3%FS
Voltage Accuracy	0.1%FS
Current Accuracy	0.3%FS
Power Resolution	0.1kW
Voltage Resolution	0.1V
Current Resolution	0.1A
Measurements	
Measurement accuracy Power	0.3%FS
Measurement accuracy Voltage	0.1%FS
Measurement accuracy Current	0.3%FS
Others	
Standard Interface	LAN/RS485
Protection	OVP, OCP, OPP, OTP
CE Conformity	EN 62040-1, EN 62040-2
Protection Level	IP21
Cooling	Forced Air Cooling
Temperature	Operating: 0~40°C, Storage: -20~85°C
Operating Humidity	20-90%RH (None Condensing)

Standard Models Specification

Model	Power	Voltage	Current	Dimension (W*D*H mm)	Weight(kg)
BSL 100-1000-200	100kW	1000V	200A	800*900*1900	1200
BSL 100-1000-300	100kW	1000V	300A	800*900*2100	1300
BSL 100-1000-400	100kW	1000V	400A	800*900*2200	1400
BSL 100-1500-133	100kW	1500V	133A	800*900*2100	1150
BSL 100-1500-200	100kW	1500V	200A	800*900*2100	1200
BSL 100-1500-266	100kW	1500V	266A	800*900*2200	1300
BSL 100-2000-100	100kW	2000V	100A	800*900*2100	1150
BSL 100-2000-150	100kW	2000V	150A	800*900*2100	1200
BSL 100-2000-200	100kW	2000V	200A	800*900*2200	1300
BSL 150-1000-300	150kW	1000V	300A	1000*900*1900	1400
BSL 150-1000-450	150kW	1000V	450A	1000*900*2100	1500
BSL 150-1000-600	150kW	1000V	600A	1000*900*2200	1600



BSL 150-1500-200	150kW	1500V	200A	1000*900*1900	1300
BSL 150-1500-300	150kW	1500V	300A	1000*900*2100	1400
BSL 150-1500-400	150kW	1500V	400A	1000*900*2200	1500
BSL 150-2000-150	150kW	2000V	150A	1000*900*1900	1300
BSL 150-2000-225	150kW	2000V	225A	1000*900*1900	1300
BSL 150-2000-300	150kW	2000V	300A	1000*900*2100	1400
BSL 200-1000-400	200kW	1000V	400A	1800*900*1800	1700
BSL 200-1000-600	200kW	1000V	600A	1800*900*2000	1850
BSL 200-1000-800	200kW	1000V	800A	1800*900*2200	2000
BSL 200-1500-266	200kW	1500V	266A	1800*900*1800	1600
BSL 200-1500-400	200kW	1500V	400A	1800*900*1800	1700
BSL 200-1500-533	200kW	1500V	533A	1800*900*2000	1800
BSL 200-2000-200	200kW	2000V	200A	1800*900*1800	1600
BSL 200-2000-300	200kW	2000V	300A	1800*900*1800	1680
BSL 200-2000-400	200kW	2000V	400A	1800*900*1800	1700
BSL 250-1000-500	250kW	1000V	500A	1800*900*2000	1900
BSL 250-1000-750	250kW	1000V	750A	1800*900*2200	2100
BSL 250-1000-1000	250kW	1000V	1000A	1800*900*2200	2300
BSL 250-1500-333	250kW	1500V	333A	1800*900*1800	1800
BSL 250-1500-500	250kW	1500V	500A	1800*900*2000	1900
BSL 250-1500-666	250kW	1500V	666A	1800*900*2200	2100
BSL 250-2000-250	250kW	2000V	250A	1800*900*1800	1800
BSL 250-2000-375	250kW	2000V	375A	1800*900*1800	1800
BSL 250-2000-500	250kW	2000V	500A	1800*900*2000	1900
BSL 300-1000-600	300kW	1000V	600A	1900*1000*2200	2400
BSL 300-1000-900	300kW	1000V	900A	2800*1000*2200	2600
BSL 300-1000-1200	300kW	1000V	1200A	2800*1000*2200	2800
BSL 300-1500-400	300kW	1500V	400A	1900*1000*2200	2300
BSL 300-1500-600	300kW	1500V	600A	1900*1000*2200	2400
BSL 300-1500-800	300kW	1500V	800A	2800*1000*2200	2550
BSL 300-2000-300	300kW	2000V	300A	1900*1000*2200	2300
BSL 300-2000-450	300kW	2000V	450A	1900*1000*2200	2300
BSL 300-2000-600	300kW	2000V	600A	1900*1000*2200	2400

Note: Total weight < 1400KG, the cabinet bottom is wheel structure; otherwise, it is channel steel structure.

AC Input Configuration ¹

Please specify the input voltage (L-L)

/380, Input Voltage 380VLL±10%, 3P+N+PE/3P+PE

/400, Input Voltage 400VLL±10%, 3P+N+PE/3P+PE

/480, Input Voltage 480VLL±10%, 3P+N+PE/3P+PE

¹ Other AC input is available, please consult factory.

Model Configuration

BSL AAA-BBB-CCC/DDD

AAA: Power, kW

BBB: Voltage range, V

CCC: Current range, A

DDD: Input configuration

About BriPower

Bridge Technology is a company focusing on business of power supplies and test systems for new energy applications. We are devoted to providing high quality products and solutions for customers.

Bridge Technology has a top-class R&D team in China, works on modularization and standardization power supplies and systems. We have sales, technical support, R&D and manufacture in Shanghai, Nanjing and Chengdu.

Nanjing Bridge New Energy Technology was founded on Jan 12th, 2016, focusing on R&D and manufacturing BriPower brand power systems, including bi-directional AC sources for grid simulation, bi-directional DC sources for battery simulation, and regenerative loads. The BriPower AC&DC power systems are widely used in new energy and related fields. BriPower is valuable to customer especially high Power and High Voltage.

Factory: Nanjing Bridge New Energy Technology Co., Ltd

Sales Company: Shanghai Bridge Electronic Technology Co., Ltd

General Information: info@bridgetech.cn

Technical Support: support@bridgetech.cn

Repair & Calibration: service@bridgetech.cn

Sales Hotline: 40010-18618

Int'l Sales: contact@bridgetech.com.sg

